

**Prestige**
STONE PRODUCTS **LLC.**

NEW



JACKSON CREEK WEATHERLEDGE

Where quality

—CRAFTSMANSHIP

is a way of life...[®]

Precision craftsmanship
in every detail





Prestige
STONE PRODUCTS LLC.



TAN NATIVESTONE

TABLE OF CONTENTS

04 RESIDENTIAL AND COMMERCIAL APPLICATIONS

14 LEDGESTONE

18 PRO STACK

22 QUARRY CUT

28 WEATHERLEDGE

32 LIMESTONE

34 NATIVESTONE



36 SALVAGED WOOD STONE

38 FIELDSTONE

42 OLD COUNTY LEDGE

48 RUSTIC MANOR LEDGE

50 THIN VENEER BRICK

52 ACCESSORIES

59 WARRANTY

60 INSTALLATION GUIDE

RESIDENTIAL APPLICATIONS



PORTLAND SMOKE OLD COUNTY LEDGE



5642



RESIDENTIAL APPLICATIONS



KODIAK RIDGE WEATHERLEDGE



RESIDENTIAL APPLICATIONS



CHARCOAL LEDGESTONE



09

COMMERCIAL APPLICATIONS

WHY PICK MANUFACTURED STONE VENEER INSTEAD OF NATURAL QUARRIED STONE VENEER ?

- NOT WEIGHT BEARING, NO NEED FOR A FOOTER OR ADDITIONAL REINFORCEMENT AND EXPANSION JOINTS
- COMPETITIVELY PRICED TO BE WELL WITHIN BUDGET CONSTRAINTS
- MUCH LARGER VARIETY OF COLORS AND SHAPES

PORTLAND MIST WEATHERLEDGE



PORTLAND SMOKE QUARRY CUT



HARVEST OLD COUNTY LEDGE



COMMERCIAL APPLICATIONS

DESERT HOLLOW WEATHERLEDGE



PORTLAND SMOKE OLD COUNTY LEDGE





CHARCOAL RUSTIC MANOR LEDGE



BLUEGRASS WEATHERLEDGE AND IMPERIAL PRO STACK

BUCK COUNTRY
LEDGESTONE



CHARCOAL
LEDGESTONE



KODIAK RIDGE
LEDGESTONE



MONTEREY
LEDGESTONE





L EDGESTONE

The LedgeStone series lends abundant character to any project. Rustic with varying depths, the texture is an appealing mix that pleases the eye. Jagged and tapered pieces abound, grasping the essence of the natural ledgeStone we mold.

DESERT HOLLOW
LEDGESTONE



SANTA FE
LEDGESTONE



HARVEST
LEDGESTONE



BLUEGRASS
LEDGESTONE



Ledgestone ranges from 1 ½ inch to 6 inches tall and 4 inches to 25 inches long.

L EDGESTONE



- With a modern look that contains clean and contemporary lines, our Pro Stack brings you the most current style. The panels are uncluttered, long, and straight-edged.

Simple yet dynamic, this choice of stone gives you the orderly, unfettered look you've been seeking .

MESA
PRO STACK



CUMBERLAND FOG
PRO STACK



BUCK COUNTRY
PRO STACK



IMPERIAL
PRO STACK



*P*RO STACK



IMPERIAL PRO STACK

MOONLIT FOREST
PRO STACK



PORTLAND SMOKE
PRO STACK



CHARCOAL
PRO STACK



PORTLAND MIST
PRO STACK



Pro Stack panels are 3 inches tall, 6 to 24 inches long, and 1 inch deep.



*P*RO STACK



FIRE
DEPARTMENT
CONNECTION

BUCK COUNTRY
QUARRY CUT



CHARCOAL
QUARRY CUT



PORTLAND SMOKE
QUARRY CUT



KODIAK RIDGE
QUARRY CUT



Quarry Cut
ranges from
1 inch to 4 ½
inches tall and
3 inches to 23 ½
inches long.





QUARRY CUT

-With a stylish and edgy feel, Quarry Cut fits the bill when you want a well-arranged look.

Chic and cultivated with its stack ledge and smaller thin pieces, it brings you uniform lines and diverse color. Perfect for a distinct look to set your design apart.

PORTLAND MIST
QUARRY CUT



MOONLIT FOREST
QUARRY CUT



BLUEGRASS
QUARRY CUT



QUARRY CUT



MOONLIT FOREST QUARRY CUT AND OLD COUNTY LEDGE

SEQUOIA
WEATHERLEDGE



MONTEREY
WEATHERLEDGE



TAN
WEATHERLEDGE



PORTLAND MIST
WEATHERLEDGE



JACKSON CREEK
WEATHERLEDGE





PORTLAND DUSK
WEATHERLEDGE



CHARCOAL WEATHERLEDGE



BORDEAUX CREEK
WEATHERLEDGE



BUCK COUNTRY
WEATHERLEDGE



CHARCOAL
WEATHERLEDGE





W EATHERLEDGE

-Our Weatherledge series is an attractive interweaving of stone that will make your next venture stand out. Eye-catchingly honed, its style is not as rugged or complex. It is characterized by smoother edges and rectangular pieces that draw you in to its allure.

HARVEST
WEATHERLEDGE



BLUEGRASS
WEATHERLEDGE



PORTLAND SMOKE
WEATHERLEDGE



KODIAK RIDGE
WEATHERLEDGE



DESERT HOLLOW
WEATHERLEDGE



Weatherledge ranges from 1½ inches to 6 inches tall and 4 inches to 23 inches long.

*W*EATHERLEDGE



KODIAK RIDGE WEATHERLEDGE



- Regional favorites tell a story about an area. A popular pick in Ohio, Limestone is the go-to preference with its old world flair. A chiseled look with a charming complexity, its a stone that gives your project the look it needs.

OHIO WHITE VEIN
LIMESTONE



FRENCH COUNTRY
LIMESTONE



GRANDVIEW
LIMESTONE



Our Limestone is approximately 2 inches to 7 inches tall by 5 inches and up to 22½ inches long.

CHESTNUT
LIMESTONE



LIMESTONE

BURNT RUSSET
LIMESTONE

SMOKEY
LIMESTONE



BURNT RUSSET LIMESTONE

TAN
NATIVESTONE



KODIAK RIDGE
NATIVESTONE



PORTLAND MIST
NATIVESTONE



JACKSON CREEK
NATIVESTONE



CHARCOAL
NATIVESTONE



Nativestone ranges in size from 2 inches to 7½ inches wide by 4 inches to 22 inches long.



NATIVESTONE

- Our Nativestone features the natural look of authentic native Ohio limestone. They are found in the Lake Erie region of Ohio.

PORTLAND SMOKE
NATIVESTONE

PORTLAND SMOKE NATIVESTONE

-Rugged, yet stunningly modern, we've designed a beautiful new look for your next project.

Minutely detailed, it brings a fresh line to your space with its weathered details. The striking reclaimed texture of this stone will give your project the finish that it deserves.

FARMHOUSE
SALVAGED WOOD STONE



NATURAL
SALVAGED WOOD STONE



SALVAGED WOOD STONE



CLEARANCE 13' 2"

-Choosing a homey look with stone brings an exciting blend of variables to choose from. Our Fieldstone clarifies this style and brings it to the forefront. With a varied and irregular woodsy union of shapes, this series is a warm invitation to come home and unwind.

BLUEGRASS
FIELDSTONE



PORTLAND SMOKE
FIELDSTONE



KODIAK RIDGE
FIELDSTONE



PORTLAND SMOKE FIELDSTONE

*F*ieldstone



TAN
FIELDSTONE



Our Fieldstone ranges from 4 inches to approximately 22 inches.

CHARCOAL
FIELDSTONE



BUCK COUNTRY
FIELDSTONE



CHARCOAL FIELDSTONE

*F*IELDSTONE



KODIAK RIDGE
OLD COUNTY LEDGE



PORTLAND MIST
OLD COUNTY LEDGE



BUCK COUNTRY
OLD COUNTY LEDGE



- With smooth faces and a modern, angular edge, Old County Ledge is the stone of choice for those seeking an orderly look.

This series is a well-organized combination of varied size and texture, but with an undeviating line.



PORTLAND MIST OLD COUNTY LEDGE



Old County Ledge

HARVEST
OLD COUNTY LEDGE



PORTLAND SMOKE
OLD COUNTY LEDGE



BORDEAUX CREEK
OLD COUNTY LEDGE



Old County Ledge



440

SANTA FE
OLD COUNTY LEDGE



BLUEGRASS
OLD COUNTY LEDGE



MOONLIT FOREST
OLD COUNTY LEDGE



PORTLAND DUSK
OLD COUNTY LEDGE



CHARCOAL
OLD COUNTY LEDGE



CHARCOAL OLD COUNTY L



Old County Ledge
ranges in size from
1½ to 7 inches
tall by 4 to 23½ long.

Old County Ledge



KODIAK RIDGE
RUSTIC MANOR LEDGE



CHARCOAL
RUSTIC MANOR LEDGE



HARVEST
RUSTIC MANOR LEDGE



Our Rustic Manor Ledge ranges in size from 1½ x 4 inches and 4 x 10 inches for the smaller pieces.

The larger pieces range from 8 x 10 to 16 x 23½ inches.

Proportions are 70% large pieces to 30% smaller pieces.

-Rustic Manor Ledge transports you to a time when each detail was crafted by hand. A place where hand-hewn walls of warm character were inlaid with provincial stone - this series brings that to life. With variegated stone shapes and rough-cut lines, it lends a fetching Italianate look to your project that will exude sophistication.

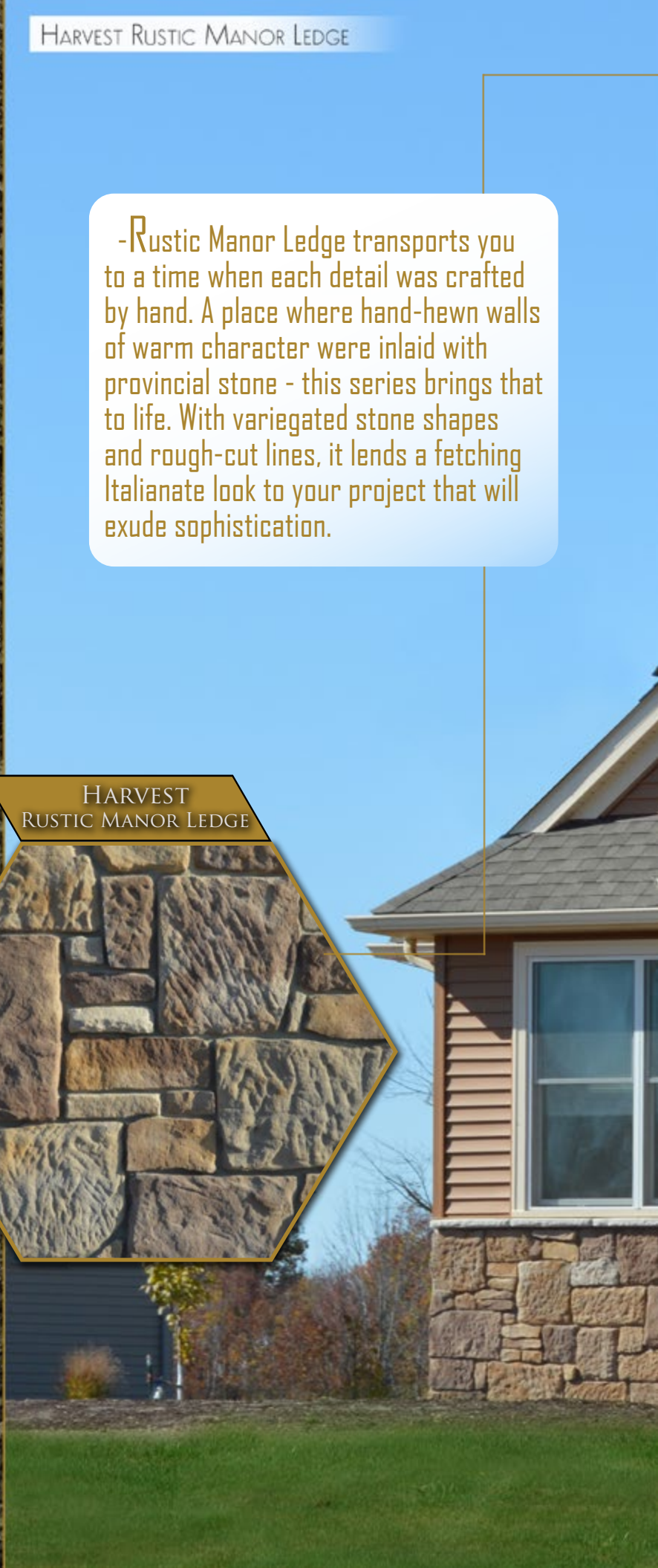

RUSTIC MANOR LEDGE



-Our Thin Veneer Brick is a throwback to when each brick was hand-made and unique. For a rustic flair our brick is perfect on your next project!

REDWOOD
THIN VENEER BRICK

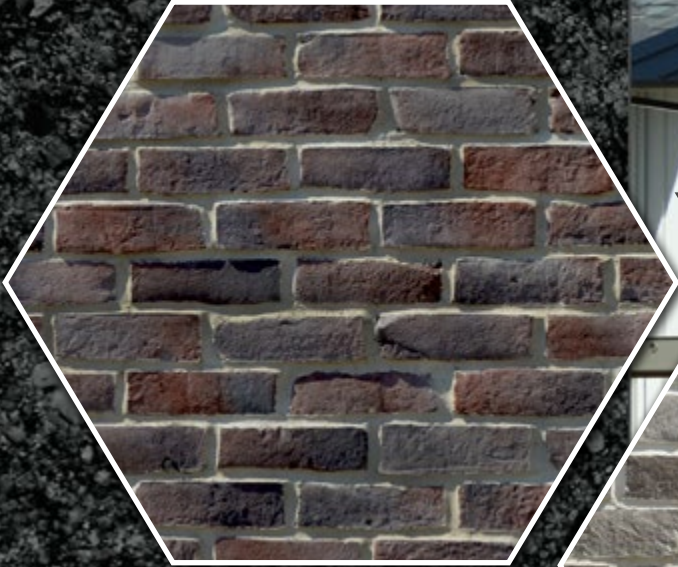

FARMHOUSE
THIN VENEER BRICK



MAHOGANY THIN VENEER BRICK























MAHOGANY
THIN VENEER BRICK

































Thin Veneer Brick is 2 ½ inches wide by 8 inches long by 1 inch deep.

Thin Veneer Brick











































ACCESSORY COLOR REFERENCE GUIDE

COLOR	WEATHERLEDGE	LEDGESTONE	OLD COUNTY LEDGE	PRO STACK
CHARCOAL				
KODIAK RIDGE				
BUCK COUNTRY				
PORTLAND SMOKE				
BLUEGRASS				
PORTLAND MIST				
HARVEST				

FIELDSTONE	NATIVESTONE	QUARRY CUT	RUSTIC MANOR LEDGE	SUGGESTED COLORS	
				 BROWN	 GRAY
				 BROWN	 GRAY
				 BROWN	 TAN
				 PORTLAND	 GRAY
				 PORTLAND	 GRAY
				 TAN	 PORTLAND
				 BROWN	 TAN

ACCESSORY COLOR REFERENCE GUIDE

COLOR	WEATHERLEDGE	LEDGESTONE	OLD COUNTY LEDGE	SUGGESTED COLORS
BORDEAUX CREEK				 BROWN  TAN
DESERT HOLLOW				 BROWN  TAN
MONTEREY				 BROWN  GRAY
SANTA FE				 BROWN  TAN
PORTLAND DUSK				 PORTLAND  GRAY
COLOR	WEATHERLEDGE	FIELDSTONE	NATIVESTONE	SUGGESTED COLORS
JACKSON CREEK				 BROWN  GRAY
TAN				 BROWN  TAN

COLOR	WEATHERLEDGE			SUGGESTED COLORS
SEQUOIA				 BROWN
	PRO STACK	OLD COUNTY LEDGE	QUARRY CUT	
MOONLIT FOREST				 BROWN  GRAY
MESA				 BROWN  TAN
CUMBERLAND FOG				 PORTLAND  GRAY
IMPERIAL				 WHITE

ALL COLORS LISTED HERE ARE FOR SUGGESTION ONLY AND ARE SOLELY AT THE DISCRETION OF THE USER. FOR COLOR, PLEASE REFERENCE STONE SAMPLES OR CURRENT INSTALLATIONS FOR COLOR REPRESENTATION.

ACCESSORY COLOR REFERENCE GUIDE

COLOR	LIMESTONE	COLOR	LIMESTONE	SUGGESTED COLORS
GRANDVIEW		OHIO WHITE VEIN		 TAN
BURNT RUSSET		CHESTNUT		 BROWN GRAY
SMOKEY				 GRAY
FRENCH COUNTRY				 TAN

ALL COLORS LISTED HERE ARE FOR SUGGESTION ONLY AND ARE SOLELY AT THE DISCRETION OF THE USER.
FOR COLOR, PLEASE REFERENCE STONE SAMPLES OR CURRENT INSTALLATIONS FOR COLOR REPRESENTATION.

ACCESSORY SIZING GUIDE

AVAILABLE COLORS



WATERTABLE SILL

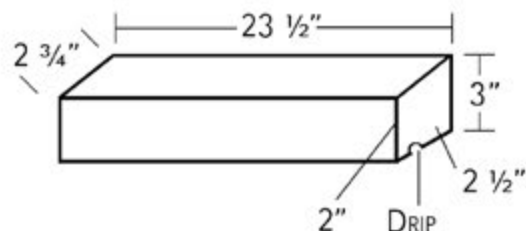

LIGHT BLOCK

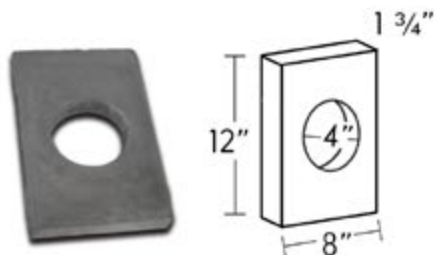

HYDRANT BLOCK

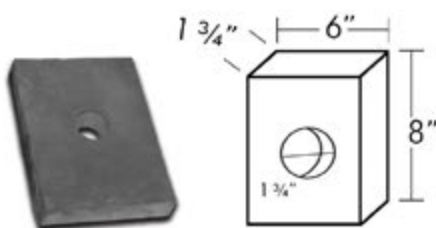

ROWLOCK

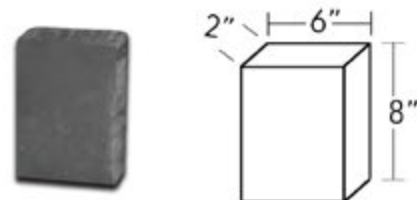

WALL CAP

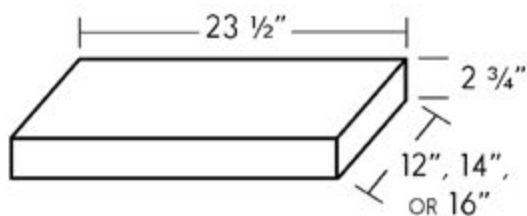

WINDOW TRIM

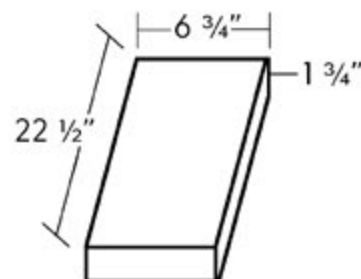

ROCKFACE KEYSTONE

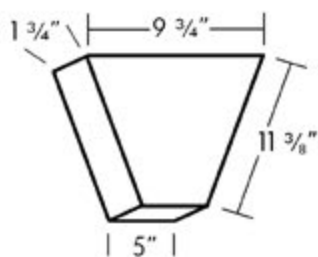

PIER CAP

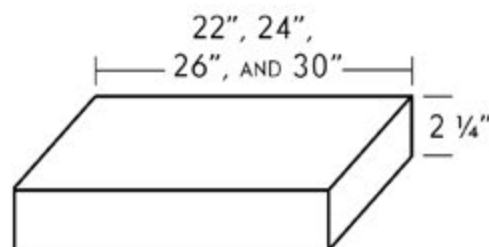

ACCESSORY SIZING GUIDE

AVAILABLE COLORS



HEARTHSTONE

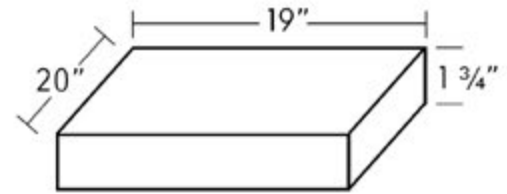

LEDGE ROCK SILL

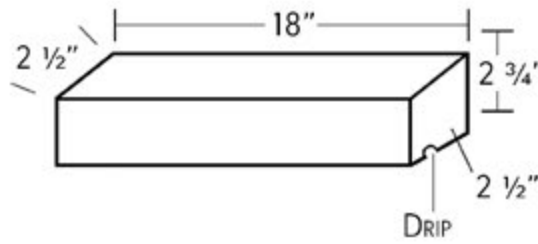

RECEPTACLE BLOCK

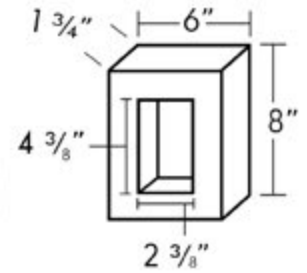

AVAILABLE COLORS



FIREPLACE MANTLE

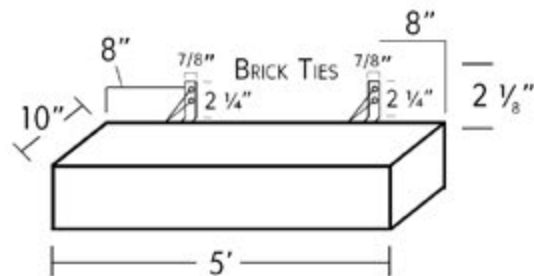

FIREPLACE BRACKET

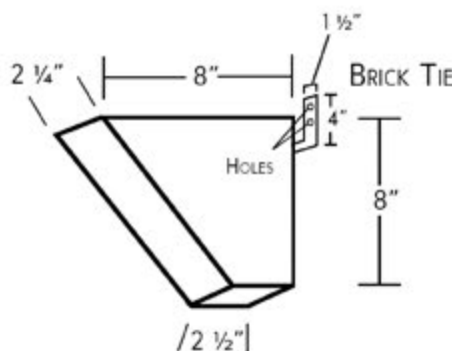

WARRANTY INFORMATION

50 year limited warranty from the date of purchase, when installed to manufacturers instructions, and installed according to local building codes. Warranty does not cover damaged product resulting from building settlement, wall movement, improper installation, or discoloration due to airborne contaminants.

Warranty is subject to all other terms of the written warranty, a copy of which can be obtained from your dealer or by visiting www.prestigestoneproducts.com.

The Contractor and Architect are responsible for proper installation. Prestige Stone Products, llc is not responsible for the structural wall surface it is applied to. Make sure to follow all of your local building codes. Building codes will vary from state to state, county to county.



PORTLAND MIST WEATHERLEDGE

INSTALLATION INSTRUCTIONS

1. Installation Over Wood Framing

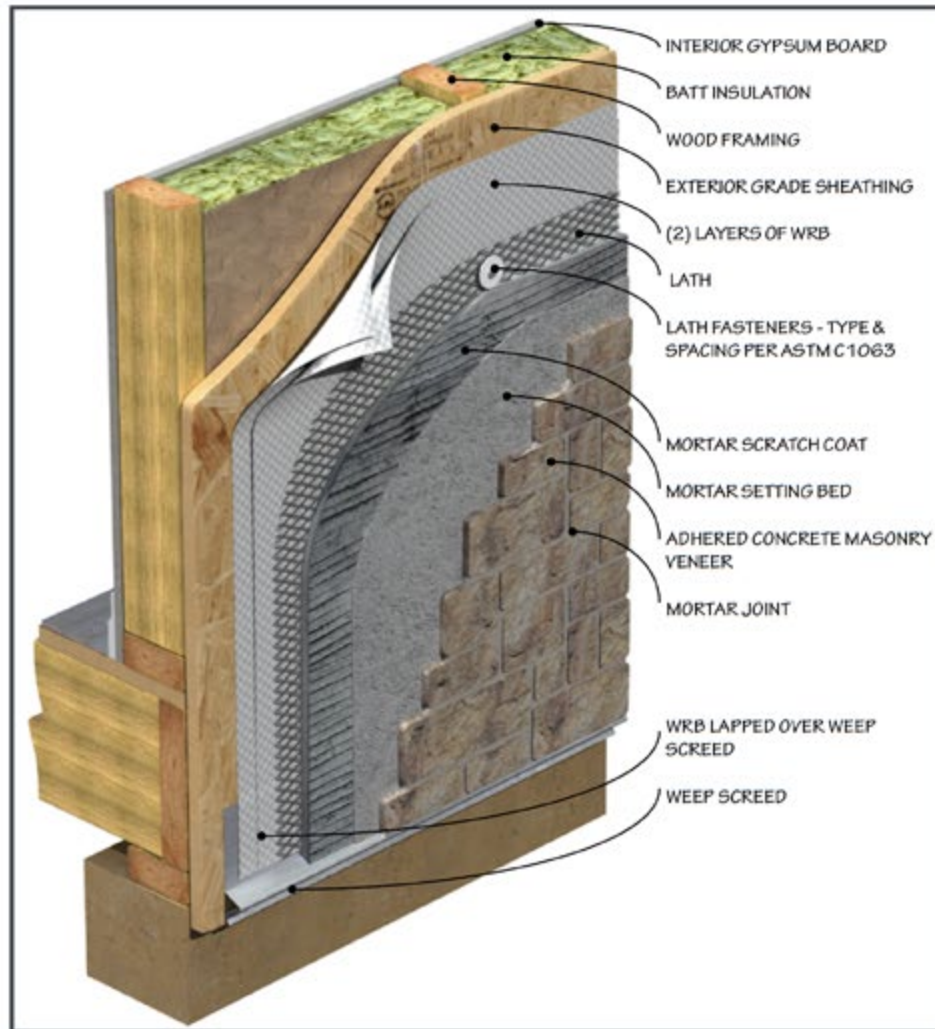

Applying the Metal Lath

Apply a moisture barrier of housewrap and 30 pound felt. Overlap horizontal joints 5 inches and vertical joints 8 inches. All corners must be wrapped a minimum of 16 inches. Then apply 2.5 pound metal lath or equivalent. Metal lath must be overlapped in the same manner as the felt. Fasten with wide crown staples at least 1 inch in length. Make sure all chimneys and windows are properly flashed.

Applying the Scratch Coat

Apply a scratch coat using Type M or Type N mortar, approximately $\frac{1}{4}$ inch to $\frac{1}{2}$ inch thick. Make sure the mortar is not too wet or too dry.

Applying the Stone

Install corners first. Spread mortar evenly on the back of the stone, approximately $\frac{1}{2}$ inch thick. When applying the stone to the wall, move the stone back and forth a little bit in a circular motion. Make sure your mortar is not too dry or too wet for proper bonding. In hot weather you may need to wet down the back of the stone or the scratch coat.

2. Installation Over Concrete Masonry Units

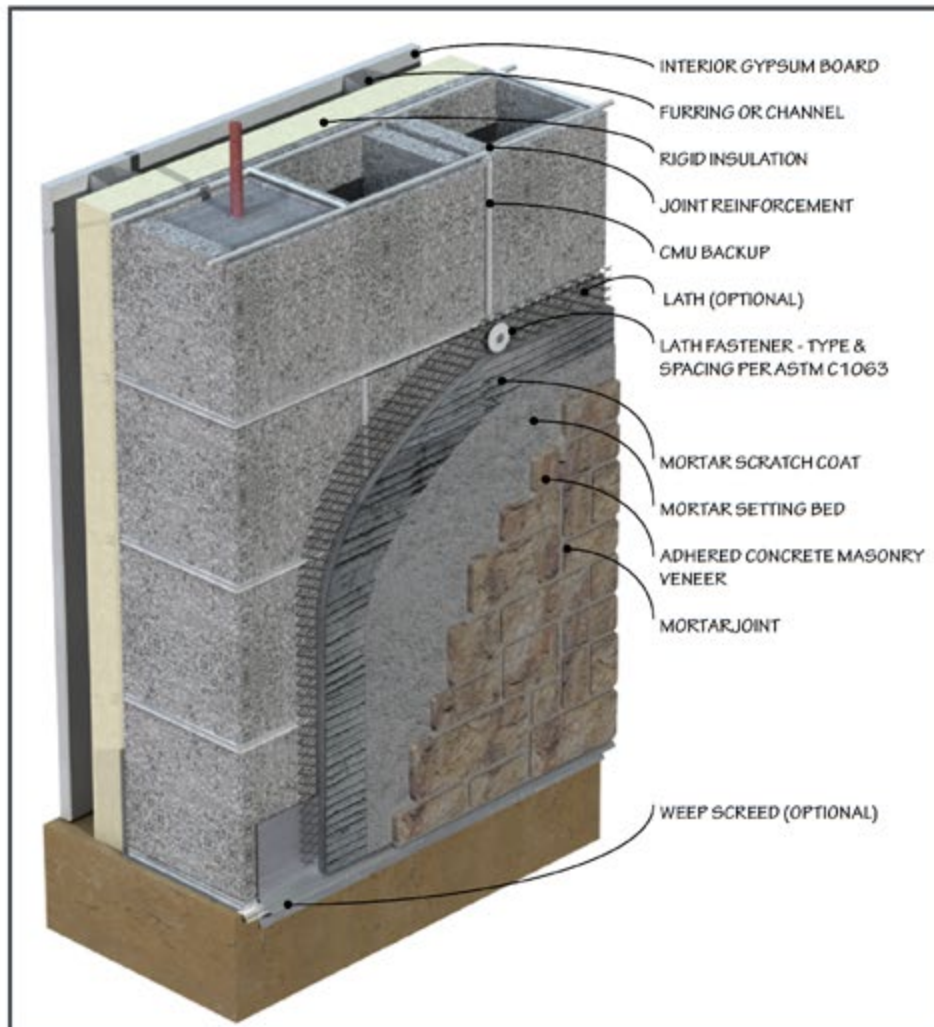

Grouting Instructions

Use a grout bag to grout the joints, making sure you do not get cement on the face of the stone. Let the grout joint set up until it is slightly dry, then strike the joint with a jointer or other similar implement. Make sure it isn't too wet or too dry. If the mortar wets or stains a brush it is too wet. Brush out the joints with a soft brush.

SCAN FOR THE
MVMA
INSTALLATION GUIDE



Prestige Stone Products

9290 Winesburg Road

Dundee, OH 44624

330.439.5318

www.prestigestoneproducts.com

